

- ^{ぶんどき}分度器の中心を点アに合わせて次の角度をかきましょう。

1 130°

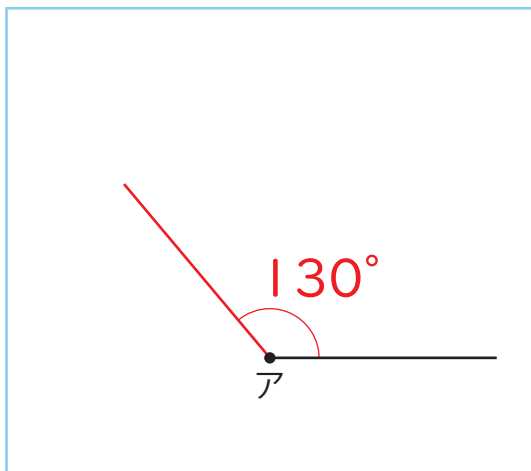

2 105°

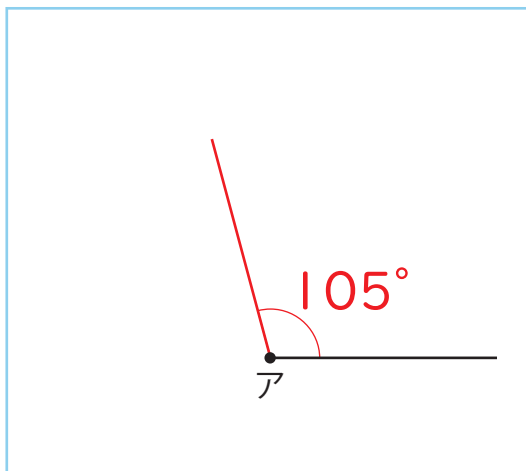

3 155°

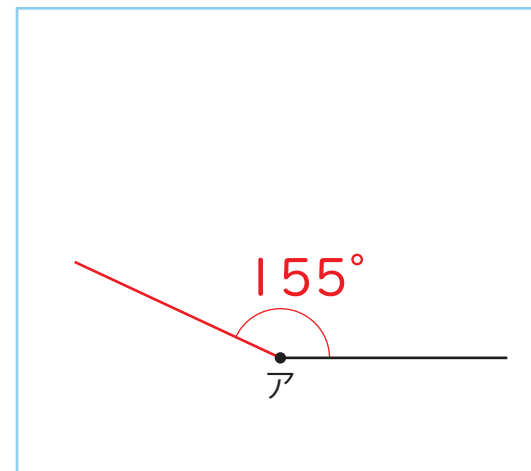

4 125°

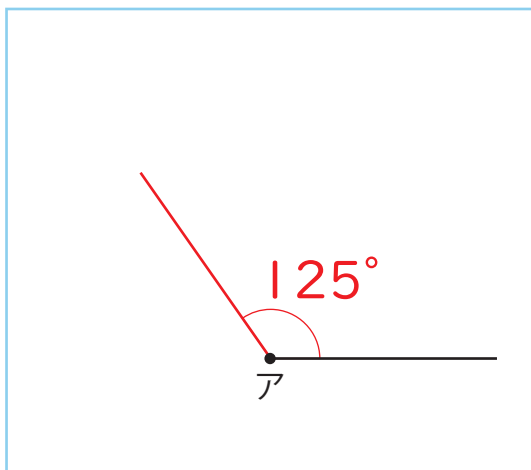

5 165°

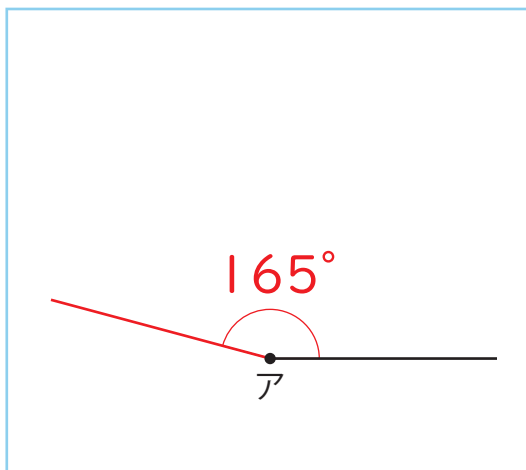

6 135°

